



G2 Series

Locks and latches



Legge has long been associated with providing Australasia industry-leading safety, security, style and convenience and the G2 cylindrical lockset is no exception. The G2 lockset offers ANSI/BHMA Grade 2 certification and the Sparta lever, with its 35mm to 45mm clearance, makes it suitable for both residential and light commercial applications requiring compliance with AS1428:1-2009 design for access and mobility code. G2 Series functions include entrance, passage, privacy, patio and dummy trim. Commercial functions such as classroom, storeroom and Vanguard options are also available for added security and safety.

Features

- Sparta lever is compliant with AS1428:1-2009
- Tested in excess of 400,000 operating cycles
- Key removable outside lever for quick and easy cylinder replacement
- Snap-on inside rose conceals mounting plate and screws
- Supplied standard with D and T strikes and spacer rings
- Two nickel silver keys per lock supplied with Schlage C4 6 pin keyway as standard
- The G2 series is ideally suited for residential, light and medium duty commercial applications
- Non-handed

Warranties	
Mechanical	10 years
Finish	allegion.co.nz/finisheswarranty

Specification guide

Series	Lever	Function	Finish				
G2	G2	Orbit	O	G10S Passage	PAS	Satin chrome plate	SCP
		Sparta	S	G40S Privacy	PRI		
				G50PD Entrance	ENT		
				G66PD Double cylinder Lock	DCENT		
				G70PD Classroom	CLA		
				G80PD Store room	STR		
				G170 Dummy trim	DUM		
				G91PD Vanguard entrance	VENT		

Note: Orbit knob only available in G50PD and G80PD Functions

1. Series

Select the desired series e.g. G2 G2

2. Lever

Select the required lever e.g. Sparta G2S

3. Function

Select the required function e.g. G50PD Entrance G2SENT

4. Finish

Select the desired finish e.g. Satin chrome plate G2SENTSCP

Specifications

Door type	Timber or metal
Door thickness	35mm to 50mm 50mm to 60mm available
Chassis	Steel, zinc dichromate plated
Lever	Pressure cast zinc
Knob	Wrought brass
Outer forend	Stainless steel
Bolt	Stainless steel
Strike plate	Stainless steel 45mm standard 22mm optional
Backsets	70mm standard, 60mm and 127mm backset latches available
Key cylinder	Schlage C6 pin keyway and C4 6 pin keyway standard, Schlage E6 pin keyway is optional

Finish



SCP

Satin Chrome Plate

Dimensions

Orbit

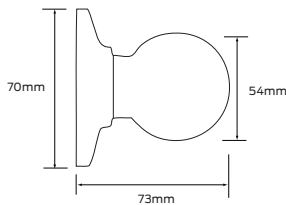

Sparta

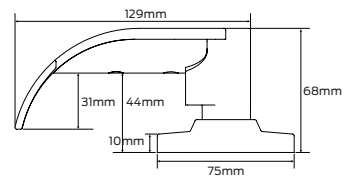

Testing and Compliance







Accessibility:
Compliant to the AS 1428:1-2009 Design for Access and Mobility





Caution:
When door closers are installed and adjusted to meet reduced opening force requirements, there may be insufficient power to reliably close and latch the door, depending on prevailing operating conditions.

Note:
In areas of high wind pressure and/or air conditioning pressures, the LCN Automatic Door Operators are recommended.

Legge G2 Series non-keyed

Functions	Outside	Inside
G10S - Passage latch Both levers always unlocked		
G30D - Patio lock Push-button locking. Turning inside lever or closing door releases button, preventing lock-out		
G40S - Bath/bedroom privacy lock Push-button locking locks outside lever. Turning inside lever releases button. Outside lever has emergency release		
G170 - Single dummy trim Dummy trim for one side of door. Used for door pull or as matching inactive trim		

Legge G2 Series keyed

Functions	Outside	Inside
G50PD - Entrance lock Turn/push-button locking, pushing and turning button locks outside lever requiring use of key until button is manually unlocked Push-button locking: pushing button locks outside lever until unlocked by key or by turning inside lever		
G66PD - Double cylinder entrance lock Key outside locks/unlocks both handles simultaneously. Key inside locks/unlocks both handles simultaneously		
G70PD - Classroom lock Outside lever locked and unlocked by key. Inside lever always unlocked		
G80PD - Storeroom lock Outside lever fixed. Entrance by key only. Inside lever always unlocked		

Legge G2 Series Vanguard option

G2 Series keyed lever locks with Vanguard provide vandal resistant technology. Designed for maximum accessibility, security, durability and function, Vanguard sets the standard for door hardware in educational facilities and other applications subject to heavy traffic or abuse. The unique features of Vanguard prevent damage to internal lock components caused by excessive force from individuals kicking, hitting or standing on the lever to gain access. In addition, total facility integration is available with the design and keying compatibility of heavy duty G2 Series lever furniture with Vanguard and standard G2 Series lever functions.

Levers are replacing knobs in the marketplace. The benefit of added grip and leverage that levers provide to those with limited mobility has, however created the opportunity for increased abuse or vandalism. This abuse often renders the lock in-operable, and in some cases, violates the security of the door. While this abuse is commonly associated with schools, it can and does occur in universities, office buildings, commercial and public buildings.

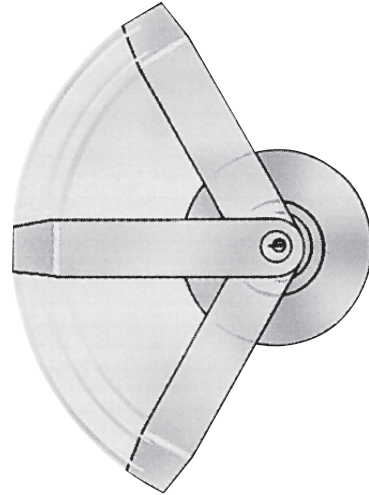

Locked lever freely rotates up and down while remaining securely locked. The Vanguard function also increases resistance to over-rotation of the lever.

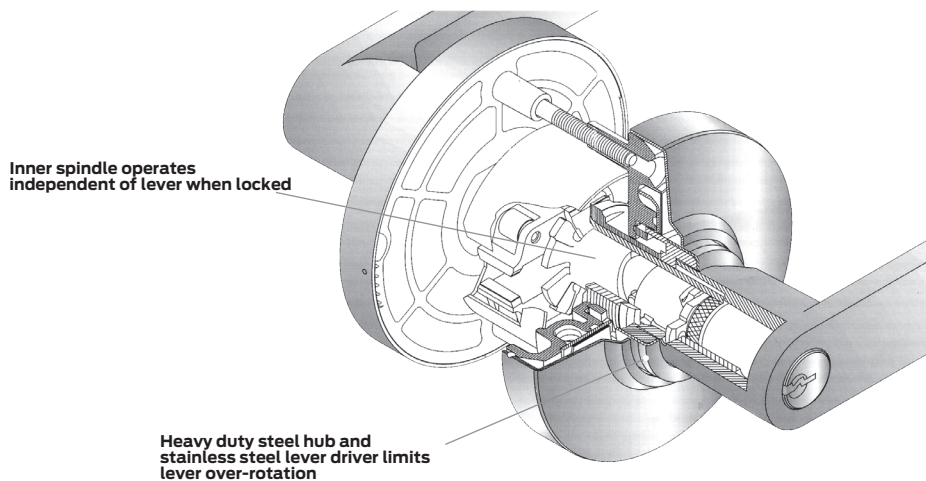

Function

Outside Inside

G91PD - Entrance/office lock

Push-button locking. Pushing button locks (disengages) outside lever until unlocked with key or by turning inside lever. Inside lever always unlocked. Vanguard is designed to disengage outside spindle from latch with in locked condition



Legge G2 Series accessories

Springlatch

Backset: 60mm, 70mm and 127mm
Finish: Satin chrome plate

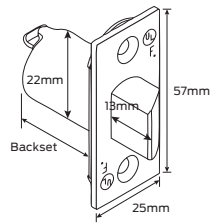

D strike

Finish: Satin stainless steel

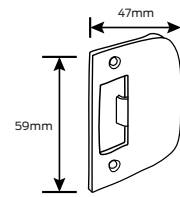

Deadlatch

Backset: 60mm, 70mm and 127mm
Finish: Satin chrome plate

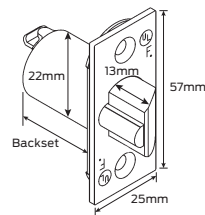

T strike

Finish: Satin stainless steel

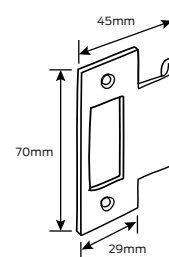

Rebate kit

This kit adapts latches and strikes for 13mm rebated door and frame preparations

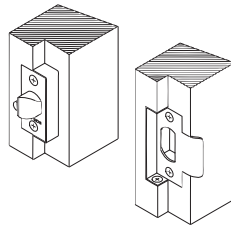

Packing ring

Finish: Satin stainless steel

